

THIS DRAWING IS UNPUBLISHED.

RELEASED FOR PUBLICATION

REVISIONS

© COPYRIGHT

ALL RIGHTS RESERVED.

P	LTR	DESCRIPTION	DATE	DWN	APVD
	B	REVISED (ECR-06-030161)	28/MAY/07	DH	JK
	B1	REVISED (ECR-18-014392)	11/SEP/18	YH	YJ

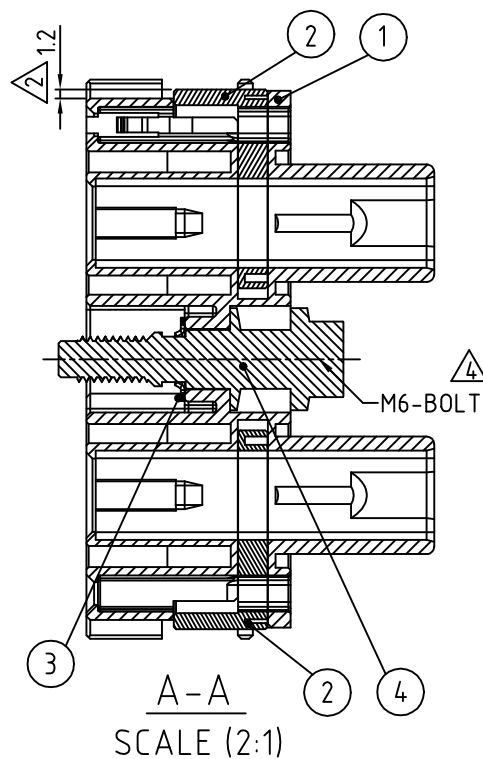
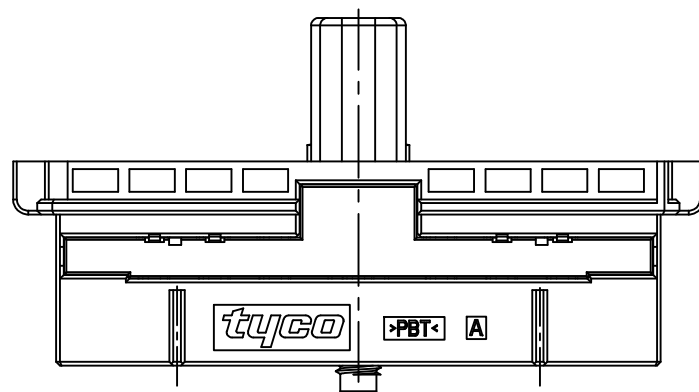

60P HYBRIDE PLUG KEY CODE.

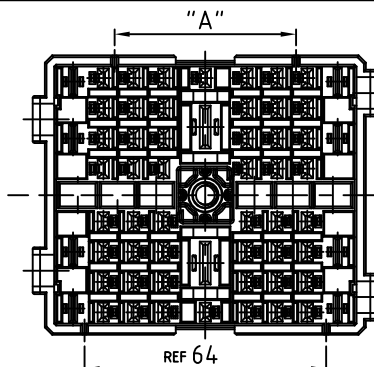

P/N	"A"	COLOR	MATERIAL
0-1743134-2	56	BLACK	PBT
1,2-1743134-3	48	GRAY	PBT

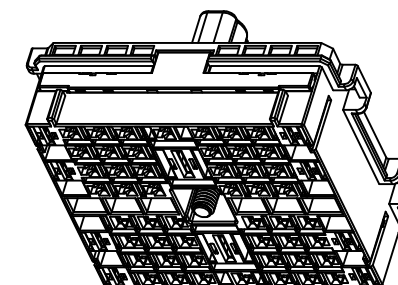

SCALE 1:2

NOTE.  
 1. GENERAL TOLERANCE IS  $\pm 0.3, \pm 3^\circ$   
 2.  $\triangle$  CONDITION OF DELIVERY : DBL PLATE PRE-ASSEMBLED POSITION  
 3. APPLIED RECEPTACLE CONTACT P/N:

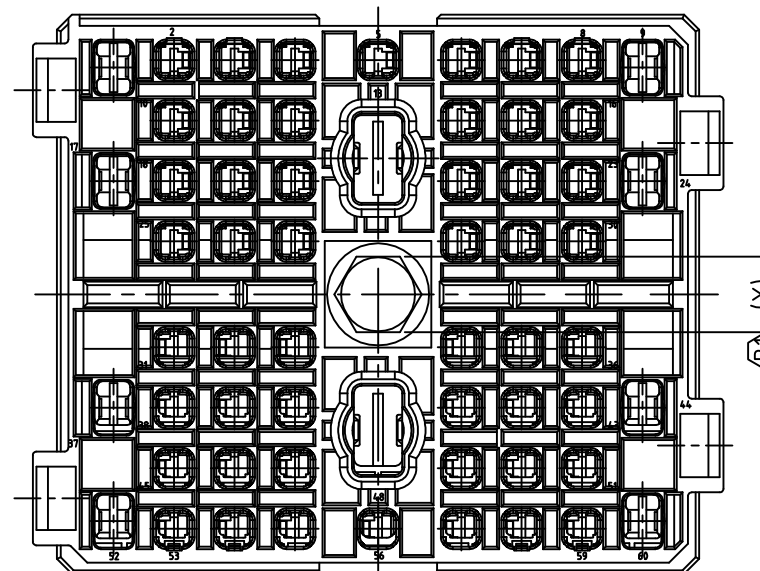
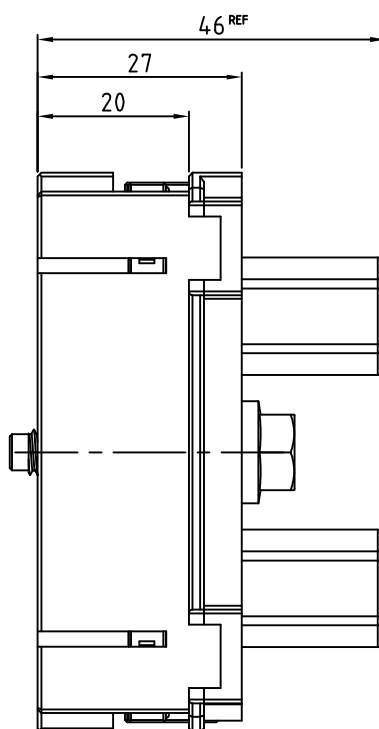
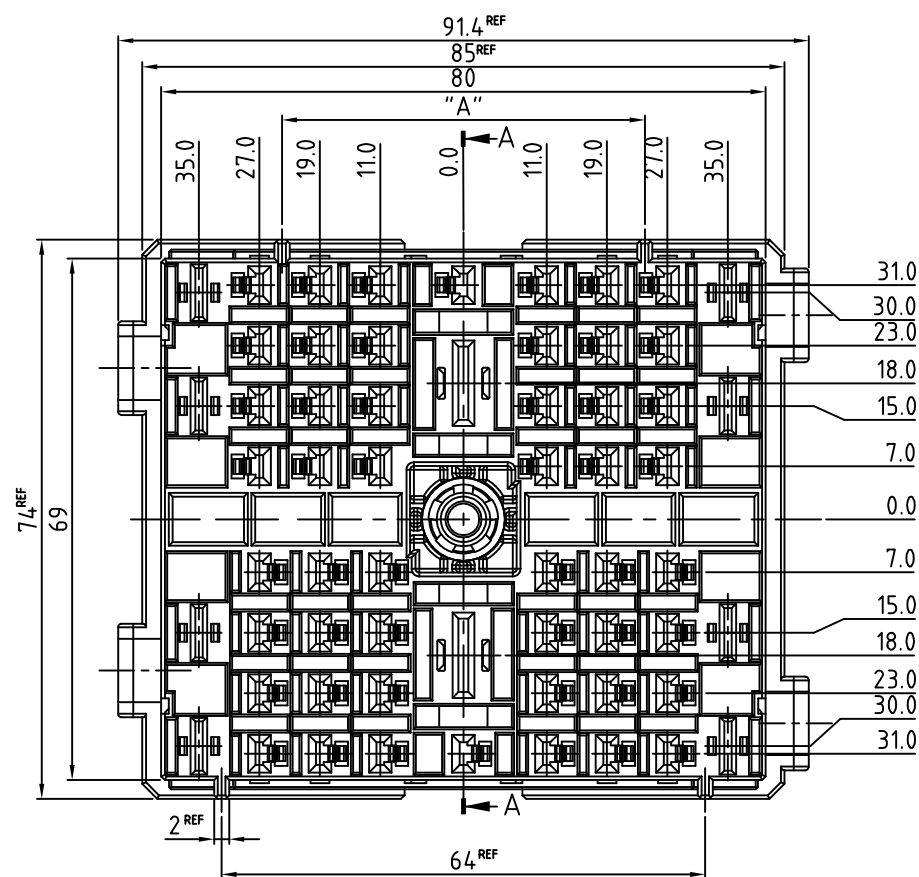

	PART No.	WIRE SIZE(mm )
MCP-E	0-1743162-1	0.3_0.85mm <sup>2</sup>
	0-1743163-1	1.25_2.0mm <sup>2</sup>
MCP 6.3	0-1241400-1	0.2_0.5mm <sup>2</sup>
	0-1241402-1	0.5_1.0mm <sup>2</sup>
	0-1241404-1	1.0_2.5mm <sup>2</sup>
	0-1241406-1	2.5_4.0mm <sup>2</sup>
MCP 9.5	0-1241408-1	4.0_6.0mm <sup>2</sup>
	1-967588-1	6.0_10.0mm <sup>2</sup>
	1-967589-1	10.0_16.0mm <sup>2</sup>

$\triangle$  Torque spec 0.8-1.0 Kgf.m

				ASSY P/N	2-1743134-3	1-1743134-3	0-1743134-2
4	M6 BOLT(8mm)	8	-	SWCH10A	1	•	•
	M6 BOLT(10mm)	10	-	SWCH10A	•	1	1
3	PUSH NUT(NEW)	-	-	SUS 304(3/4H)	1	1	1
2	DBL	-	NATURAL	PBT	2	2	2
1	PLUG	-	GRAY	PBT	1	1	•
		-	BLACK	PBT	•	•	1
	NAME	"X"	COLOR	MATERIAL	Q'TY		

THIS DRAWING IS A CONTROLLED DOCUMENT.

DIMENSIONS: mm	TOLERANCES UNLESS OTHERWISE SPECIFIED:
	0 PLC $\pm$ 1 PLC $\pm$ 2 PLC $\pm$ SEE NOTE 3 PLC $\pm$ 4 PLC $\pm$ ANGLES $\pm$
MATERIAL	FINISH
SEE TABLE	

DWN YH MA	NAME
CHK YH MA	
APVD YJ YOUN	SIZE
PRODUCT SPEC	
APPLICATION SPEC	CAGE CODE
WEIGHT	DRAWING NO
CUSTOMER DRAWING	RESTRICTED TO

**TE** TE Connectivity  
 HYBRID 60P PLUG ASS'Y  
 (BOLT TYPE)

A3	00779	C=	1743134	SCALE 1/1	SHEET 1 OF 1	REV B1
----	-------	----	---------	-----------	--------------	--------